

MH-1500SC/HP Specification

NiMH Cylindrical Battery
High power type Size: SC

Typical Characteristics

Model: MH-1500SC/HP		
Specifications		
Nominal Voltage (V)		
1.2V		
Capacity*	Typical (mAh)	1500
	Minimum (mAh)	1500
Dimension	Diameter (mm)	22.5 ^{-0.7}
	Height (mm)	43.0 ^{-1.0}
Charging**	Standard	150mA x 16 hrs
	Quick	1500mA x 1.2 hrs -ΔV = 5mV
Operating Temperature (°C)	Standard Charging	0 ~ 40°C
	Quick Charging	0 ~ 40°C
	Discharging	-20 ~ 50°C
	Storage	-20 ~ 30°C
Service Life	>500 cycles (IEC standard)	
Internal Resistance	Max. 10mΩ (after fully charge)	
Weight	Approx.37 g	
Cuff-off Voltage	0.8V	

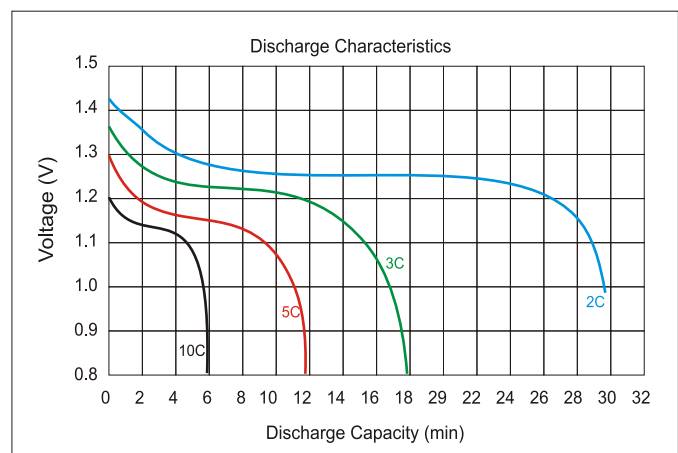
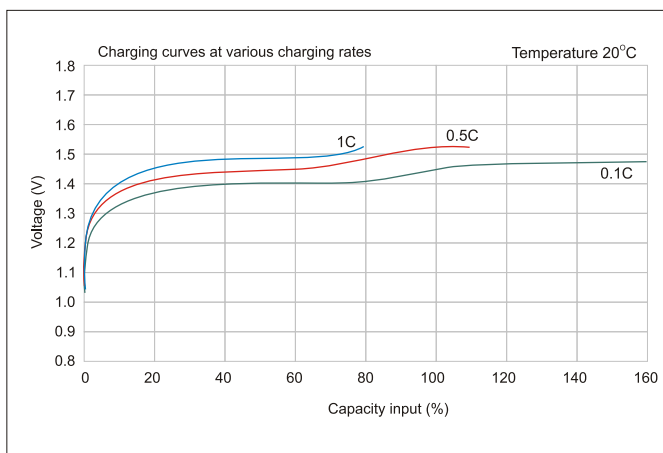
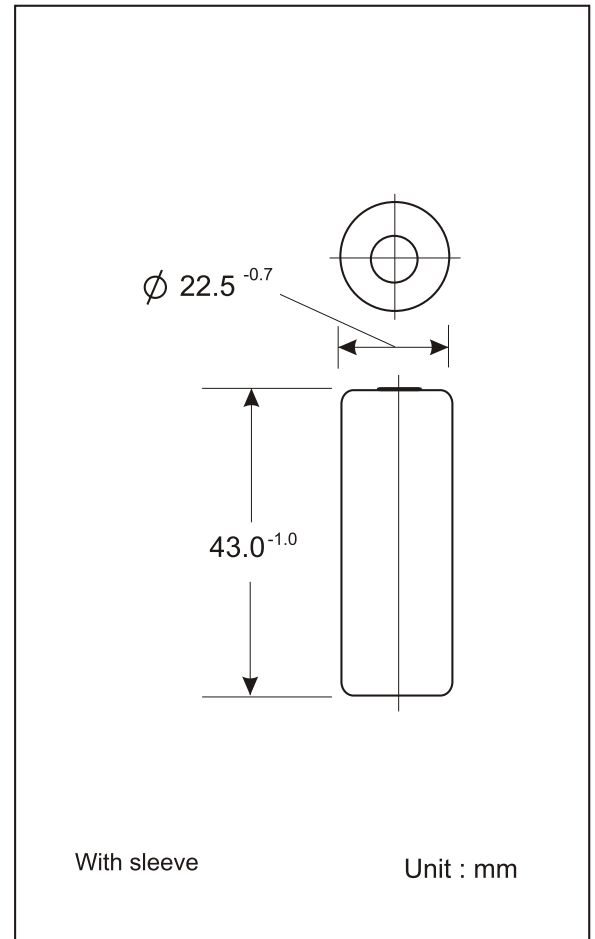

**Note: The data in this document are for descriptive purposes only and subject to change without prior notice.